

**NOTE** - If you wish to wire short-cuts with a different central, same with counts, etc., you may use the same wiring as indicated on this page.

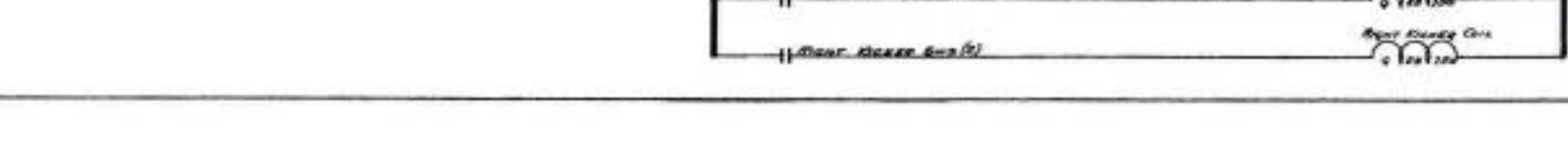
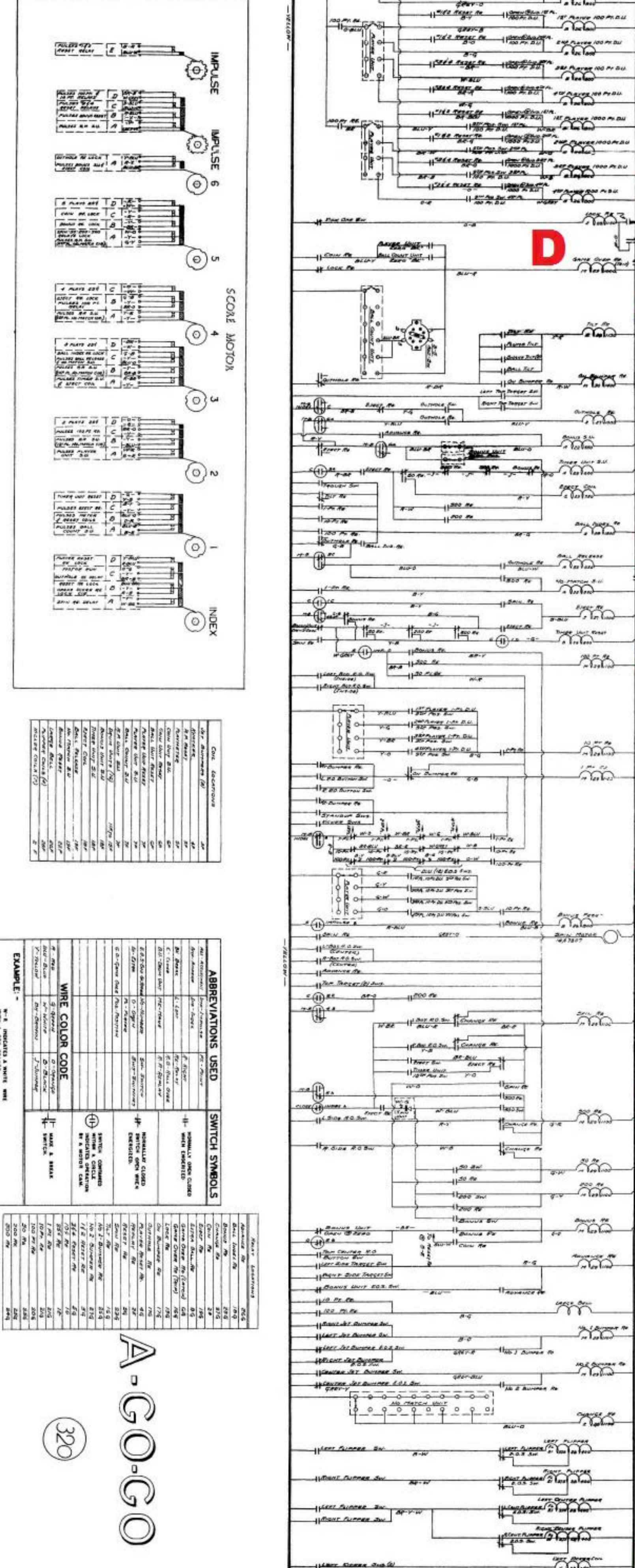
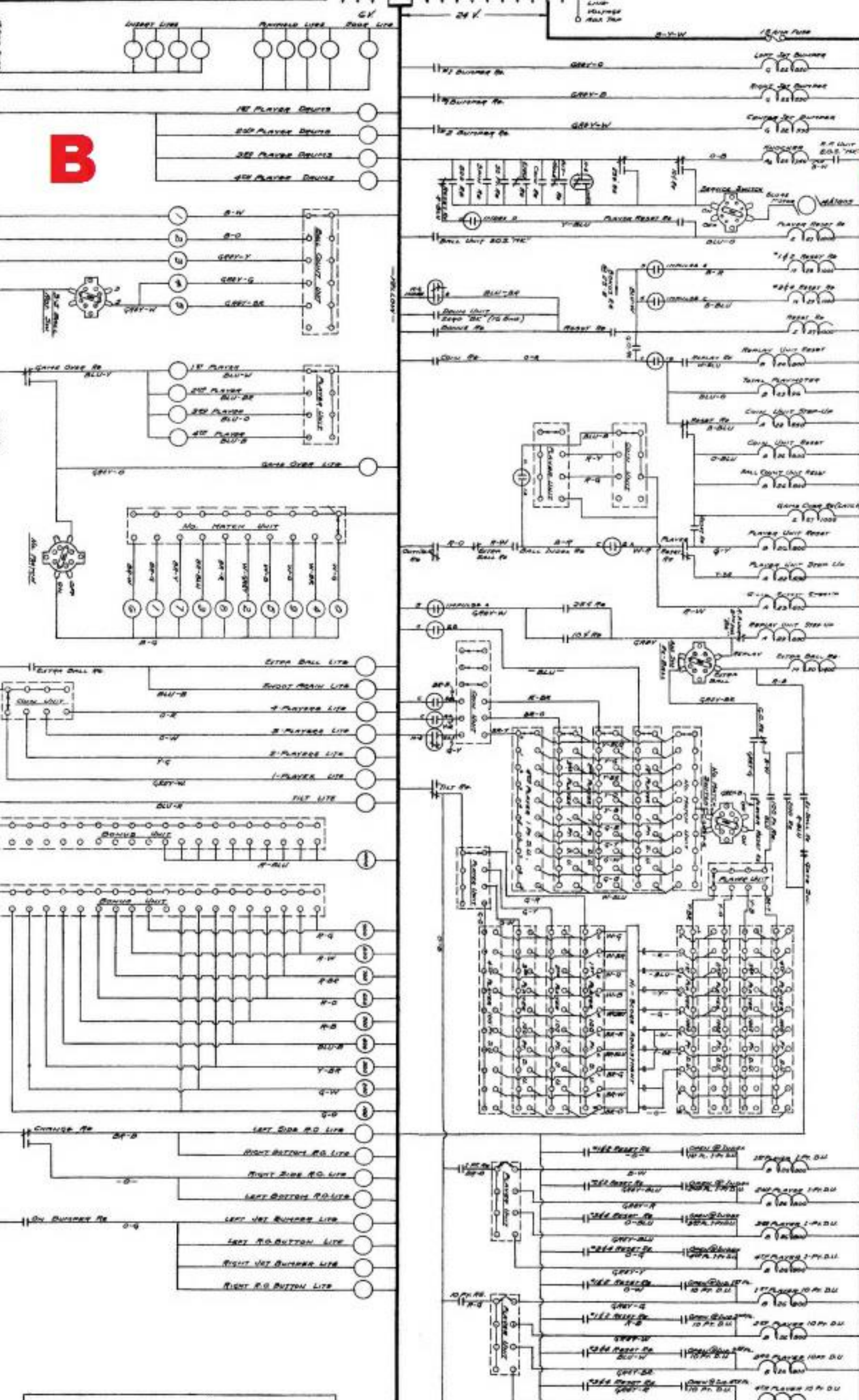
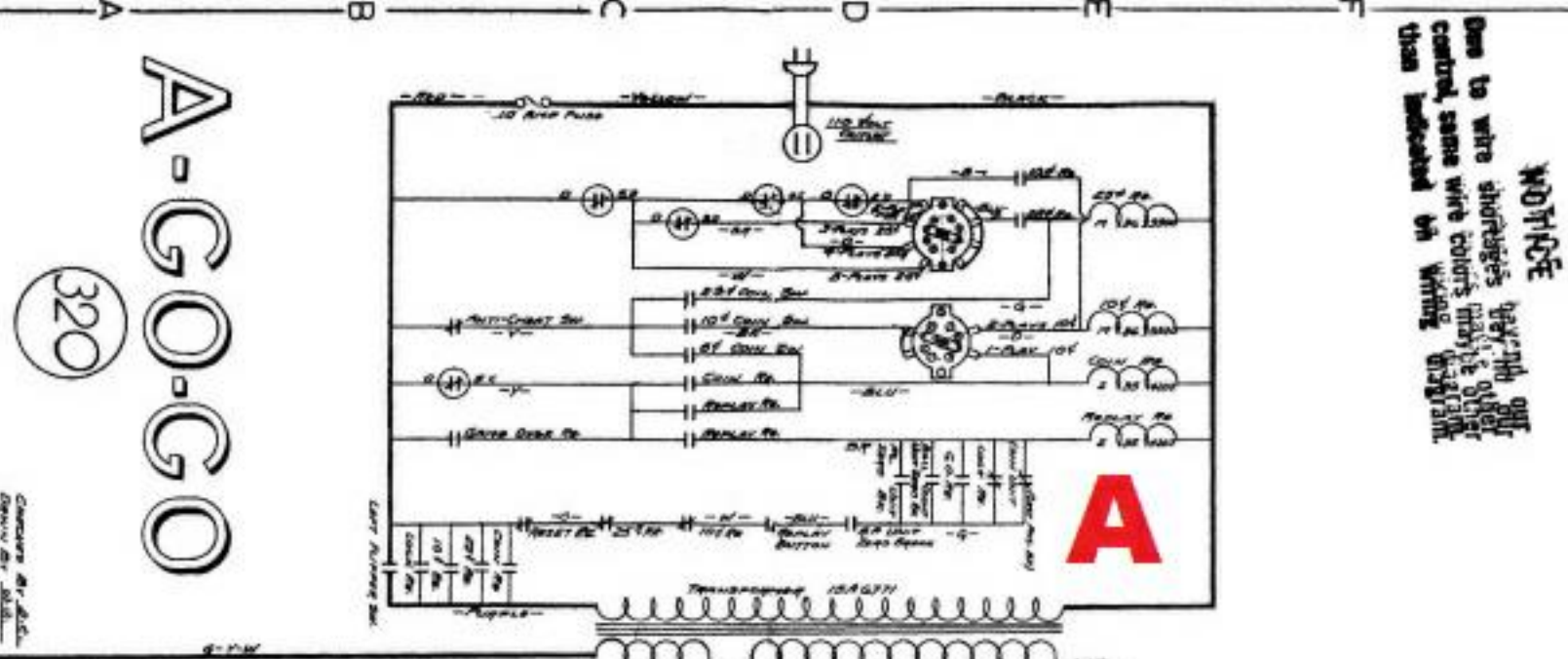

**A-G-O-G-O**  
320

**B**

**C**

**C**

**C**

**C**

**C**

**C**

**C**

**C**

**C**

**C**

**C**

**C**

**C**

**C**

**C**

**C**

**C**

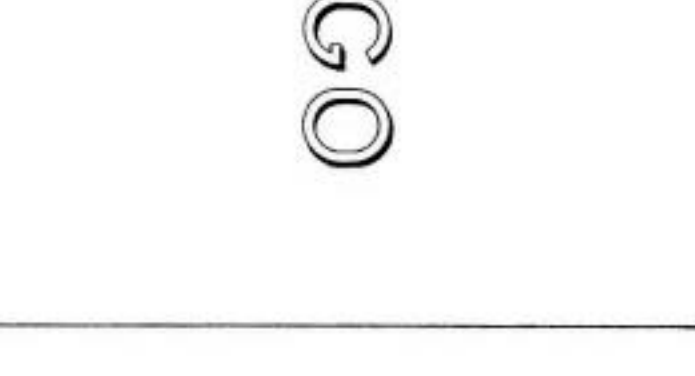
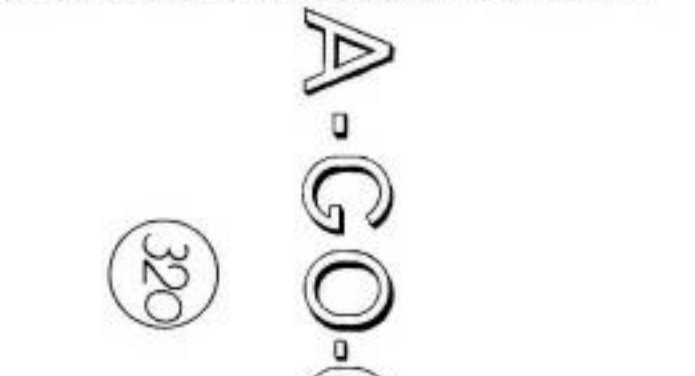
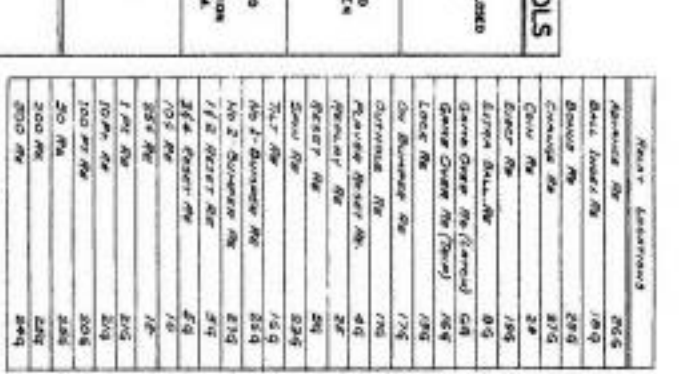
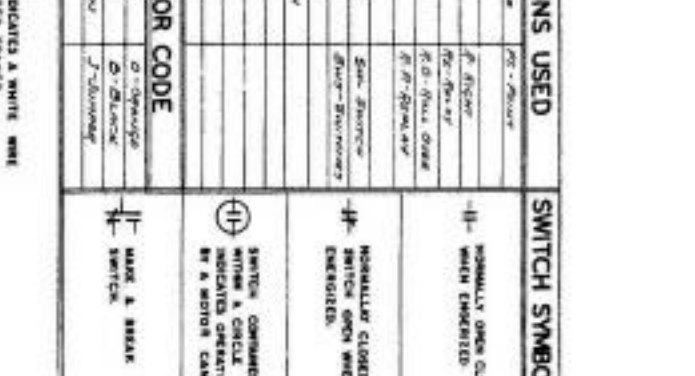
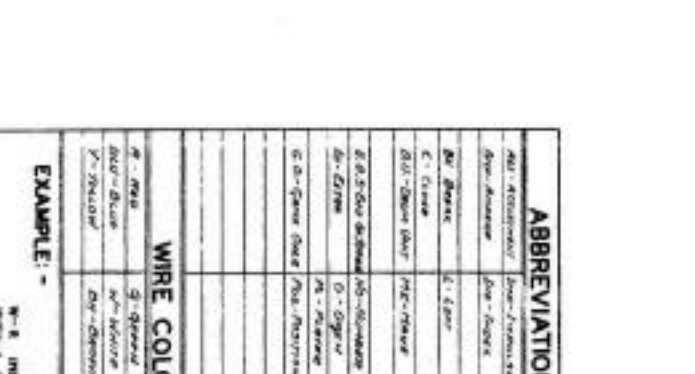
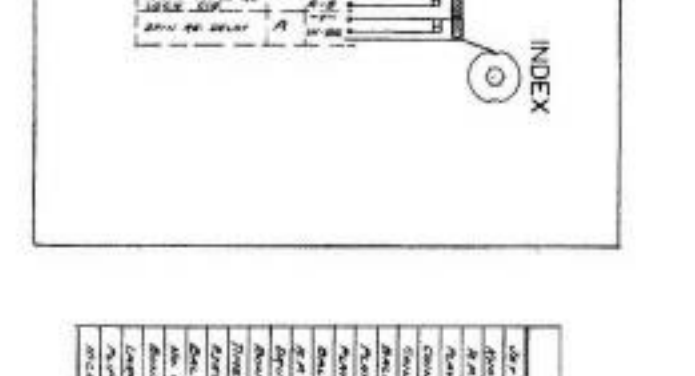
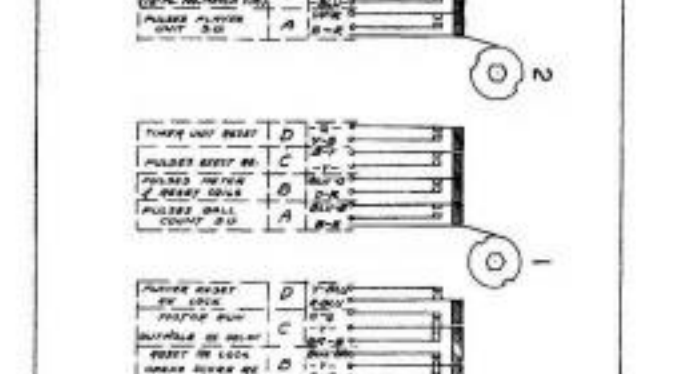
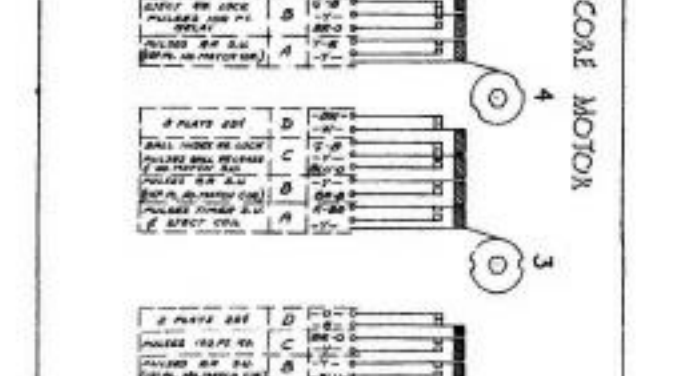
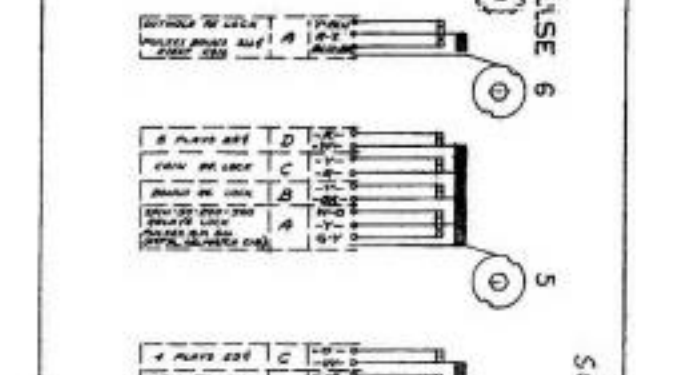
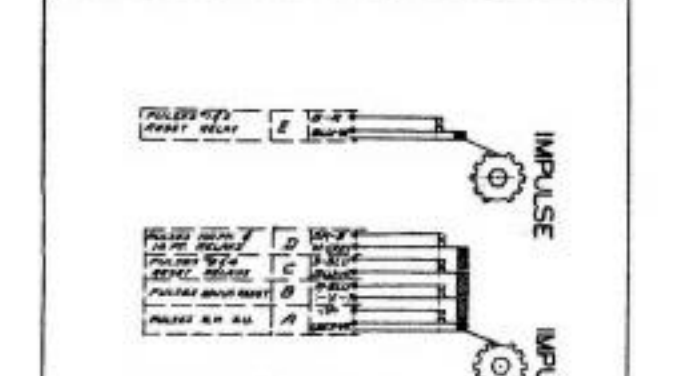
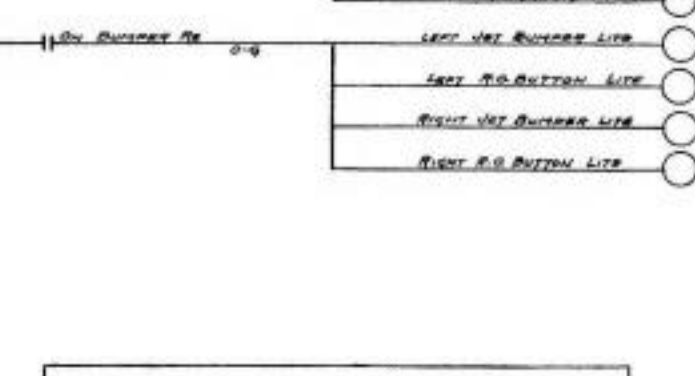
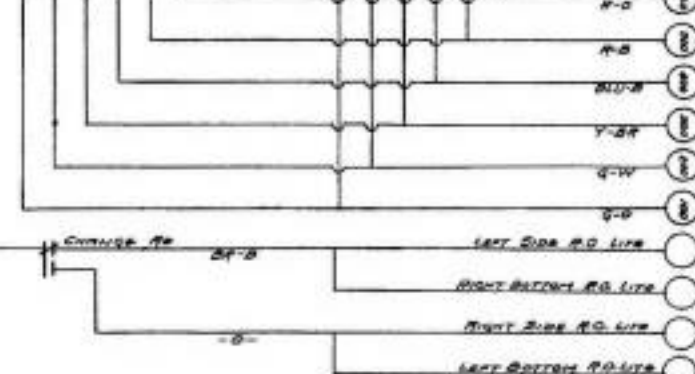
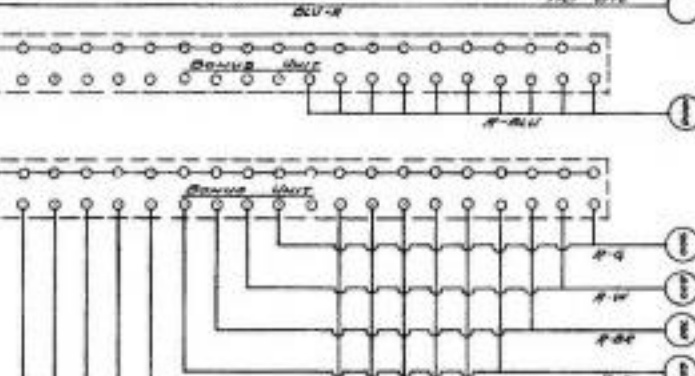
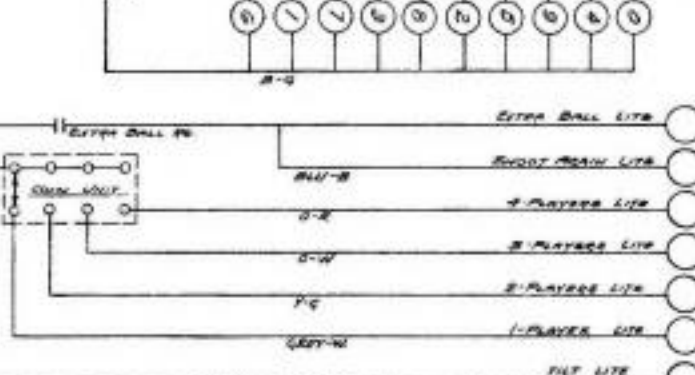
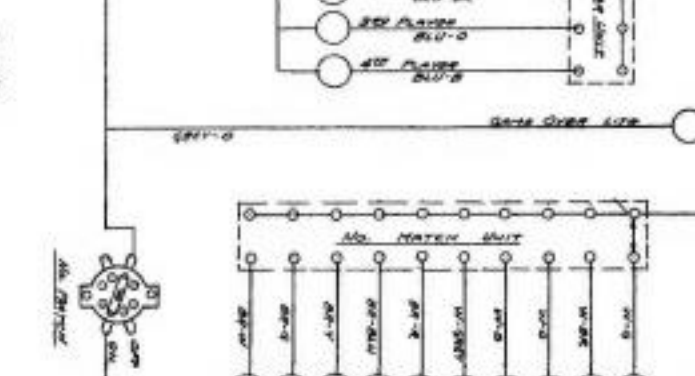
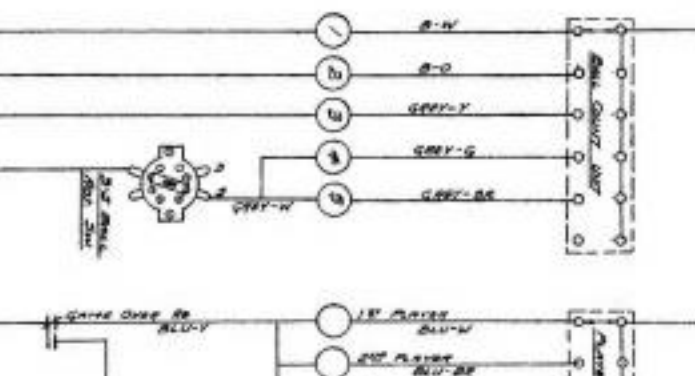
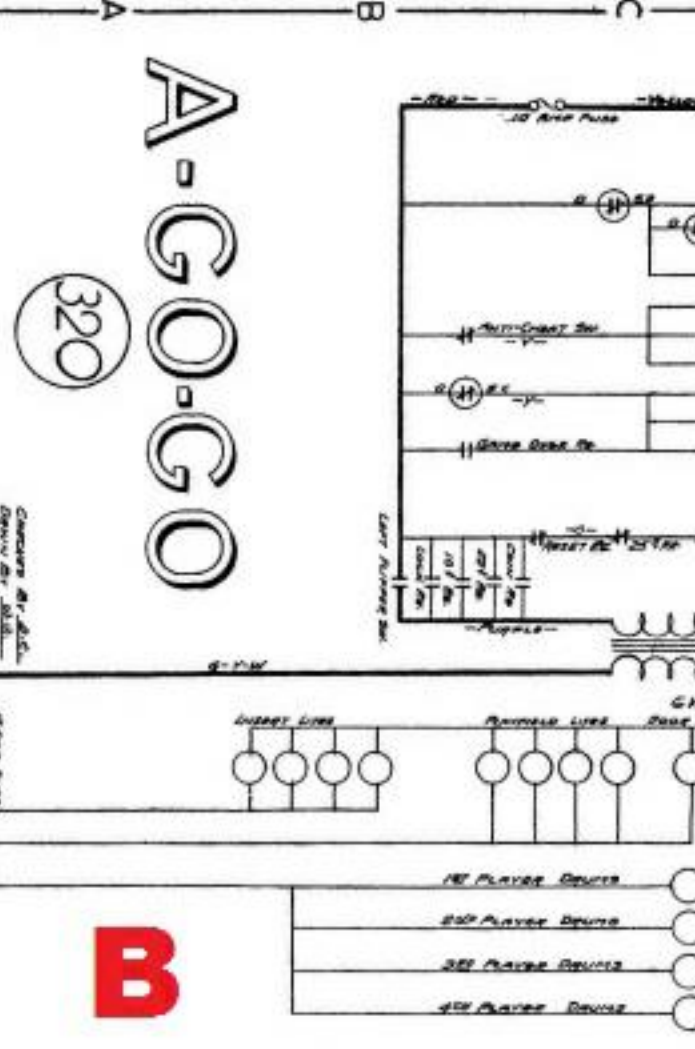

**A-G-O-G-O**  
320

**B**

**C**

**C**

**C**

**C**

**C**

**C**

**C**

**C**

**C**

**C**

**C**

**C**

**C**

**C**

**C**

**C**

**A-G-O-G-O**  
320

**B**

**C**

**C**

**C**

**C**

**C**

**C**

**C**

**C**

**C**

**C**

**C**

**C**

**C**

**C**

**C**

**C**

**A-G-O-G-O**  
320

**B**

**C**

**C**

**C**

**C**

**C**

**C**

**C**

**C**

**C**

**C**

**C**

**C**

**C**

**C**

**C**

**C**

**A-G-O-G-O**  
320

**B**

**C**

**C**

**C**

**C**

**C**

**C**

**C**

**C**

**C**

**C**

**C**

**C**

**C**

**C**

**C**

**C**

**A-G-O-G-O**  
320

**B**

**C**

**C**

**C**

**C**

**C**

**C**

**C**

**C**

**C**

**C**

**C**

**C**

**C**

**C**

**C**

**C**

**A-G-O-G-O**  
320

**B**

**C**

**C**

**C**

**C**

**C**

**C**

**C**

**C**

**C**

**C**

**C**

**C**

**C**

**C**

**C**

**C**

**A-G-O-G-O**  
320

**B**

**C**

**C**

**C**

**C**

**C**

**C**

**C**

**C**

**C**

**C**

**C**

**C**

**C**

**C**

**C**

**C**

**A-G-O-G-O**  
320

**B**

**C**

**C**

**C**

**C**

**C**

**C**

**C**

**C**

**C**

**C**

**C**

**C**

**C**

**C**

**C**

**C**

**A-G-O-G-O**  
320

**B**

**C**

**C**

**C**

**C**

**C**

**C**

**C**

**C**

**C**

**C**

**C**

**C**

**C**

**C**

**C**

**C**

**A-G-O-G-O**  
320

**B**

**C**

**C**

**C**

**C**

**C**

**C**

**C**

**C**

**C**

**C**

**C**

**C**

**C**

**C**

**C**

**C**

**A-G-O-G-O**  
320

**B**

**C**

**C**

**C**

**C**

**C**

**C**

**C**

**C**

**C**

**C**

**C**

**C**

**C**

**C**

**C**

**C**

**A-G-O-G-O**  
320

**B**

**C**

**C**

**C**

**C**

**C**

**C**

**C**

**C**

**C**

**C**

**C**

**C**

**C**

**C**

**C**

**C**

**A-G-O-G-O**  
320

**B**

**C**

**C**

**C**

**C**

**C**

**C**

**C**

**C**

**C**

**C**

**C**

**C**

**C**

**C**

**C**

**C**

**A-G-O-G-O**  
320

**B**

**C**

**C**